



# McDonald Water Storage

## **STEEL***flow* Direct

### **INSTALLATION MANUAL V1 2022**

### **DIRECT UNVENTED ELECTRIC WATER HEATER WITH *EXTERNAL* EXPANSION VESSEL**

#### **IMPORTANT**

This range of water heaters and unvented water storage cylinders should only be installed as per these instructions by a competent & certified heating installer. By installing this product you agree to be bound by the purchasing and warranty terms and conditions found in this manual and on our website.



## INTRODUCTION

This UK manufactured product is made from Duplex stainless steel, providing durability and long-lasting resistance against corrosion. It is highly insulated with environmentally friendly foam, and enclosed in a rust resistant outer steel case.

The Direct is a Direct Electric Water Heater as defined under the current ErP Directive and available in eight sizes from 60-300litres.

The cylinder is approved to comply with G3 Building Regulations and the United Kingdom Water Supply (Water Fittings) Regulations / Scottish Water Byelaws.

This Direct cylinder comes supplied with all necessary safety & control devices needed to connect to the water mains. If for any reason you suspect this may not be the case, please contact us (see back page).

**Please ensure that you have understood this manual before starting the installation, and leave this guide with the end user once the installation is complete.**

**For information on potential Warranty Exclusions – please see the appendix of this installation manual.**

## BENCHMARK

The Benchmark scheme places responsibilities on both manufacturers and installers. The purpose is to ensure that customers are provided with the correct equipment for their needs, that it is installed, commissioned and serviced in accordance with the manufacturer's instructions by competent persons and that it meets the requirements of the appropriate Building Regulations and relevant electrical qualifications. The Benchmark Checklist can be used to demonstrate compliance with Building Regulations and should be provided to the customer for future reference.

Installers are required to carry out installation, commissioning and servicing work in accordance with the Benchmark Code of Practice which is available from the Heating and Hotwater Industry Council who manage and promote the scheme.

Visit [www.centralheating.co.uk](http://www.centralheating.co.uk) for more information.

## COMPONENT LISTING

Cold Water Inlet Set	LOOSE
15 x 22mm Tundish	LOOSE
Temperature & Pressure Relief Valve	FITTED
Expansion Vessel & Mounting Bracket	LOOSE
Nut connection for Expansion Vessel	LOOSE
Immersion Heater(s) - Capacity and configuration dependant	FITTED
Installation Manual	LOOSE
Benchmark Logbook - Found at the back of this manual	LOOSE

## GENERAL INSTALLATION REQUIREMENTS

The cylinder must be installed, commissioned and maintained by a competent installer holding a current G3 unvented qualification, and/or being a member of a competent persons' scheme. Once the unit is installed and commissioned, the user must be given an explanation of the operation of the cylinder and its key safety components. In addition, the end user must be given this installation manual for future reference.

## STORAGE AND HANDLING

Care must be taken when handling the product. Seek assistance when moving the product as required, and follow safe working practices and lifting techniques to avoid injury or product damage. Before installation, the cylinder must be stored upright in its original packaging, on a secure, level surface within a dry and frost-free environment.

## SITING THE UNIT

This product must be installed vertically on a flat base that is capable of supporting the maximum-fill weight of the cylinder. For each metre an outlet is above the cylinder, the supply pressure of the hot water will be reduced by 0.1 bar.

The minimum recommended cupboard size is 650mm square as the product diameter can vary (capacity and configuration dependant) between 475mm to 580mm. This is to ensure that there is access to the cylinder safety controls/immersion heaters and for future valve maintenance or replacement during service. Therefore, please ensure all connections are outward facing towards a door or similar opening for this purpose.

Areas subject to freezing should be avoided. If the cylinder is sited outside of a heated area of the dwelling, such as a garage or outbuilding, ensure the provision of adequate frost protection, such as insulation of exposed pipework. Pipe lengths must be kept to a minimum to ensure minimal losses.

## COLD WATER INLET CONTROL SET

Included in your unvented safety components is a multibloc inlet control group. This single unit is standard issue for many unvented water systems, and comprises of many different safety valves, housed into a single brass casting. This is detailed as follows:

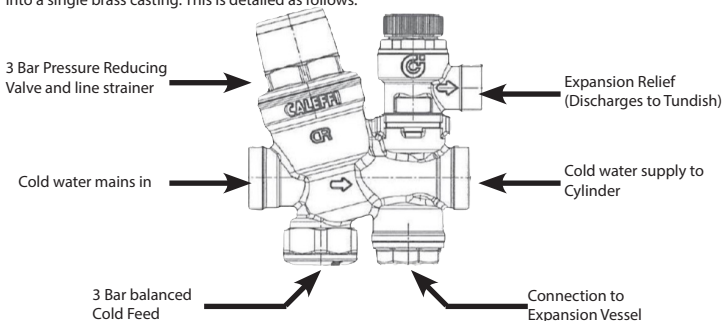

## WATER SUPPLY

We recommend that the maximum on-site water demand be assessed and the water supply be tested to ensure it meets the following requirements.

It must be noted that a high mains water pressure does NOT always guarantee a high flow rate. Ensure a working (not static) condition site pressure reading is taken. The minimum mains water supply requirements should be 0.15MPa (1.5 bar) working pressure, and a 20 litres per minute flow rate available. Where mains inlet pressures may exceed 10 bar, an additional upstream pressure reducing device should be fitted in addition to the cold water inlet set provided.

The mains supply pipe-work should be a minimum of 22mm. This could warrant the replacement of any existing 1/2" (15mm) cold mains pipe-work.

The water supply must be of a wholesome water quality, defined as Fluid Category 1 in the Water Supply Regulations 1999. In areas of hard water content (CaCO<sub>3</sub>) greater than 200ppm, treatment should be installed.

## CHANGE OF WATER SUPPLY

The changing or alternation of one water supply to another can be detrimental on the operation and/or life expectation of the product and its accessories. Where a water supply changeover occurs, e.g. a rainwater tank supply, bore water supply, desalinated water supply, public reticulated water supply or water brought in from another supply, then water chemistry information should be sought, or should be tested to ensure the supply will meet the requirements given in these guidelines for our manufacturer's warranty to apply.

## CYLINDER SUPPLY AND SAFETY DISCHARGE SCHEMATIC

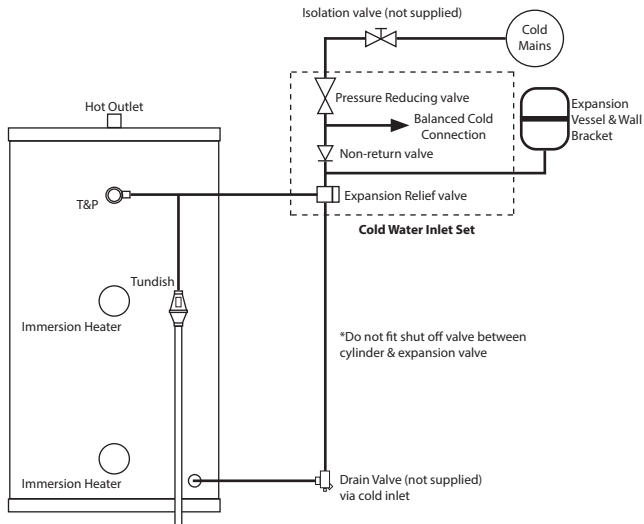

### GENERAL INSTALLATION AND COMMISSIONING

**PLEASE NOTE - THE WATER CONNECTION BOSSES AND THE OLIVES & GLAND NUTS SUPPLIED AS STANDARD ON THIS DIRECT ARE 3/4" BSP.**

#### COLD MAINS PIPEWORK

The cold mains pipework should be a minimum of 22mm, through to the cylinder installation to ensure that hot water flow requirements for taps and shower heads are met. Care should be taken to avoid inefficiency and heat transfer where cold water pipes run adjacent to hot water or heating pipework. Install an isolating valve (not supplied) to the cold mains pipework. A 22mm BS1010 stopcock or a quarter turn full-bore lever valve should be used rather than a screwdriver slot or other similar valve. Make the connection to the cold feed of the cylinder, incorporating a drain valve.

Position the inlet control set above the Temperature and Pressure Relief Valve (T&P) found on the side of the cylinder. This ensures the cylinder does not need to be drained in order to service the inlet control. Ensure the directional flow arrow on the inlet control follows the flow of water.

Mount the external expansion vessel in a suitable position to the wall using the provided bracket, and connect the pipework to the expansion vessel connection provided on the cold water inlet set. There must be no obstruction or flow restriction between the cylinder and the expansion vessel.

You must ensure that the cylinder does not fill to a pressure of greater than 3.0bar. If there are to be any showers, bidets, or monobloc taps in the installation (or wherever mixing/blending water fittings are installed) then a balanced cold supply is necessary, otherwise there is the danger of a mains fed cold service pressure leaching into the controlled hot circuit. Such back pressure would be detrimental to the system and could cause the unwarranted operation of discharge valves.

It is essential that the cold service be balanced throughout the property by taking the cold services from the **balanced cold connection** on the inlet control set. Should this not be possible an independent 3.0bar inlet pressure reducing valve must be installed into the cold supply of any such mixed fitting, suitably positioned so as to not compromise water flow to the cylinder. An outside hose tap may still be connected direct to the incoming cold supply if desired.

## **HOT WATER PIPEWORK**

The majority of the hot water distribution pipework should be 22mm, possibly reduced to 15mm or 10mm dependant on the type of tap. Keep the hot draw off pipework to a minimum to maximise the transfer speed of hot water from cylinder to outlet.

If the balanced cold connection is not provided, do not use monobloc mixer taps or showers. This would cause the unit to back pressurise and result in discharge. Ensure that the top of the vessel is accessible for servicing.

## **SECONDARY CIRCULATION**

We do not recommend a secondary return system with electrically heated cylinders. We would rather advise the use of a trace heated circuit. Where secondary circulation is unavoidable, a circulator suitable for potable water must be used in conjunction with a non-return valve to prevent backflow. The return connection should be made with a swept tee into the cold feed pipework directly above the drain connection. It may be necessary to incorporate an extra expansion vessel into the circuit to accommodate an increased system volume in larger secondary circulation systems.

## **IMMERSION HEATER**

All standard supply is with immersion heater elements of 3 Kilowatt output at 240 Volts, Incoloy elements, double pole thermal isolation and a 1¼" BSP threaded head.

## **ELECTRICAL CONNECTION - 3kW**

This appliance must be earthed. It is suitable for a 240 volt A.C. supply only. The electrical installation should only be carried out by a suitably qualified electrician in accordance with latest I.E.E. regulations. Ensure the electrical supply is isolated before working on the system.

The electrical supply to each immersion heater must be fused at 13A via a double pole isolating switch with a separation of at least 3mm to both poles to BS 3456.

The cable must be 2.5mm<sup>2</sup> heat resistant (85°C HOFR) sheathed flex complying to BS EN 50525. Do not use a cable of lesser rating.

For immersion heaters other than 3kW consult wiring requirements supplied with the immersion heater.

Do not operate the immersion heater(s) until the unit is full of water. If any sterilization liquid is in the cylinder do not operate the immersion heater(s) as this will cause premature failure.

Earth connection, (green & yellow), should be made firmly to the earth post marked "E", using the terminal attachments provided. Live connection, (brown), from the mains supply cable to the thermostat terminal marked "L". Neutral connection, (blue), from the mains supply cable to the thermostat terminal marked "N".

## **WIRING - 3kW**

Our 3kW immersion heaters MUST be wired in 2.5mm<sup>2</sup> heat resistant cable, as failure to do so can cause nuisance tripping. We will be unable to support your installation until this has been corrected. For alternate higher wattage immersion heaters, consult the instructions supplied with the device.

## COMMERCIAL/HEAVY DUTY USE

For commercial/heavy duty installations with constant usage/reheat requirements or where an external programmer designed for immersion heaters is not present then Titanium immersion heaters must be fitted in order to comply with the warranty.

## RECOMMENDED TEMPERATURE SETTINGS

For domestic usage a temperature set of 55°C-60°C is the norm. This is above the growth temperature area for Legionella and low enough to prevent nuisance tripping and unnecessary scaling.

## THERMOSTAT OPERATION

The thermostat has an adjustable control operating between 20°C and 65°C. The usual desired domestic setting is between 55°C and 60°C. The thermostat is supplied set at 60°C. For setting the stat, turn fully clockwise to the maximum, and then anticlockwise (back off) approximately a quarter of its travel. Then make minor adjustments to suit your personal taste.

## THERMAL CUTOUT

If the cylinder begins to overheat (80°C), the thermal cut-out will activate, isolating both the live and negative connections within the immersion heater. This may also happen during a power spike. For resetting, isolate the power supply and allow the cylinder to cool down. Remove the head cap and press the high limit cut-out reset button on top of the thermostat. Should nuisance tripping occur, consult a qualified electrician to investigate the power supply and/or the thermostat itself.

## REPLACEMENT IMMERSION HEATERS - ALL TYPES

Replacement immersion heaters are available in all formats for your water heater. These should be obtained via ourselves to ensure the correct specification is supplied, and our warranty not compromised. The standard heater has incoloy elements, a 1 3/4" BSP threaded head and standard rating of 3kW at 240 volts. Check the label detail on the head before ordering, as alternative specifications are available.

The 'O' ring on the head of the immersion heater should be correctly positioned and lubricated with a WRAS approved silicon lubricant before fitting. Screw in by hand until almost sealed and then gently finish tightening as the 'O' rings will seal easily. Remake the wiring connection as per instructions provided.

## INSULATION OF THE TEMPERATURE & PRESSURE RELIEF VALVE

Components for insulating the T&P are supplied in order to retain heat and energy. Installation instructions are provided with the insulation cover.

## DISCHARGE ARRANGEMENT

**The diagram opposite was taken directly from UK government Building Regulations Part G: 2016.**

**This information is not exhaustive. If in doubt, seek advice. Full details of Building Regulation G3, is available from: [www.planningportal.gov.uk](http://www.planningportal.gov.uk)**

The discharge from both the temperature, and expansion relief valves can be joined together via a 15mm end feed tee. Water should only be discharged when there is a fault with the system, and be visible at the tundish. (Consider a safety device to alert those of impaired vision or mobility when this occurs.)

Discharge water must not be allowed to collect in the pipe-work but rather flow freely to the tundish. This should be vertically mounted, in a visible location, in the same space as the cylinder, and fitted as close as possible within 600mm of the safety device (the relief valves). The discharge pipework must be in accordance with Part G3 of the Building Regulations. These are as follows:

- The discharge pipe (D2) from the Tundish should have a vertical section of pipe 300mm long below the Tundish before any elbows or bends in the pipework.
- This pipe should then be installed with a continuous fall of at least 1 in 200 thereafter.
- The pipe must be at least one pipe size larger than the nominal outlet size of the safety device (unless its total equivalent hydraulic resistance exceeds that of a straight pipe 9m long i.e. discharge pipes between 9m and 18m equivalent resistance length should be at least two sizes larger than the nominal outlet size of the safety device, between 18 and 27m at least 3 times larger and so on.) Bends must be taken into

account in calculating the flow resistance. An alternative approach for sizing discharge pipes would be to follow the BS6700 Specification for the design, installation, testing and maintenance of services supplying water for domestic use within buildings and their curtilages.

Discharge pipework should terminate in a safe place where there is no danger to persons in the vicinity of the discharge. Examples of acceptable discharge arrangements include:

- To a trapped gully with the outlet below a fixed grating and above a water seal.
- Downward discharges to low level, within 100mm, above external surfaces such as a car park, hard standing, grassed area with a protective wire cage to prevent contact but retaining visibility of discharge.
- Into a metal hopper at high level with a metal downpipe and a clearly visible termination point or onto a roof capable of withstanding high temperature discharge at least 3m away from any plastic guttering.

Building Regulation G3 allows non-metallic pipework within the tundish discharge (D2). The discharge pipe (D2) should be made of a) metal or b) another material that has demonstrated it can safely withstand high temperature water discharges and is clearly and permanently marked to identify the product and the performance standard. The discharge should not be connected to a soil discharge stack unless it can be demonstrated of safely withstanding high temperature water discharges, in which case it should;

1. Contain a mechanical seal, not a water trap, which allows water into the branch pipe but not foul drain air to be ventilated through the tundish.
2. Be a separate branch pipe with no sanitary appliances connected to it.
3. Plastic pipes used as branch pipes with the discharge should be Polybutalene (PB) or cross linked polythene (PEX) complying with national standards such as Class S of B7291-2 or Class S of BS7291-3 respectively.
4. Be continuously marked with a warning that no sanitary appliances should be connected to the pipe.
5. Plastic pipes should be joined and assembled with fittings appropriate to the circumstances in which they are used as set out in BS EN 1043-1.

Queries regarding specific discharge arrangements should be directed to your local building control office.

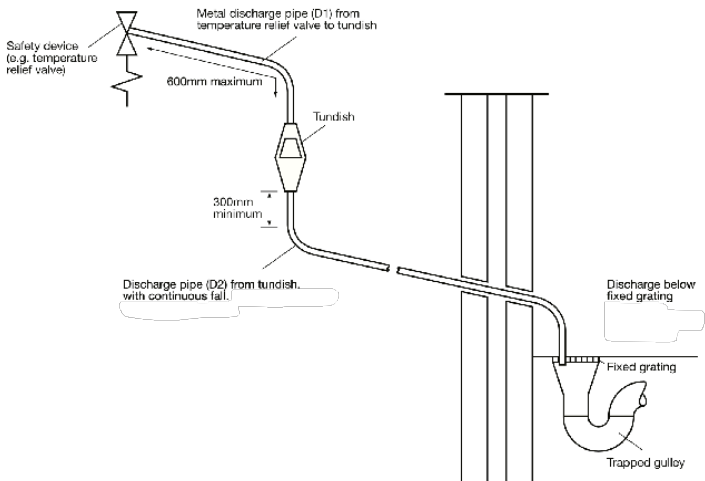

## COMMISSIONING - FILLING THE SYSTEM

Check all connections for water tightness including factory made connections, as these may become loose in transit. The expansion vessel should be 3 bar (45PSI).

The hot tap furthest away from the cylinder should be opened before filling the system to purge air and flush any disturbed particles.

The pipes should be flushed before use. The remaining taps should be opened in turn to purge air from the system before turning on the electrical supply.

For Direct Units: Fully fill and flush the system before activating the immersion heaters and allowing the unit to heat up. The immersion heater is supplied pre-set at 60°C. Turning fully to + is approximately 65°C.

## STORAGE TEMPERATURE

A storage temperature of 55-60°C is normal for domestic usage.

## SAFETY VALVE CHECK

A problem is occurring if water is released from either safety valve during the heat up process (temperature relief and expansion relief.) This must be rectified before continuing. Both valves should be opened slowly one at a time, and then together, allowing as much water as possible through the tundish. Check that the discharge pipework is cleared of obstruction, free flowing, and without spillage over the tundish. Check that the valves reseal correctly when released.

## DRAINING PROCESS

Isolate the unit from the electric supply to prevent immersion heater burn out. Isolate the unit from the cold mains. Attach a hose to the draining tap. Ensure this reaches to a level below the unit for creating an effective siphon so that the maximum amount of water is drained from the unit. Open the hot tap closest to the unit and open the draining tap.

**Caution: Water drained off may be hot.**

## SERVICE AND MAINTENANCE

- Servicing must be carried out annually by competent installers.
- Any spares used must be purchased from us.
- Safety devices must not be bypassed. Do not use the unit if safety features are not fully operational.
- Proof of annual servicing is required to avoid invalidating your manufacturer's guarantee.
- Upon installation of the unit the installer must complete the accompanying commissioning certificate at the rear of this manual.

## ANNUAL SERVICING PROCESS

This must be conducted by a competent installer on an annual basis, ideally at the same time as the annual boiler service:

1. The expansion relief valve should be eased open to allow water to flow for a minimum of 5 seconds. Close the valve and make sure it resets correctly. Repeat this procedure with the temperature & pressure relief valve. Ensure that the discharge pipework is cleared and allowing a free flow of discharge.
2. Ensure all fitted immersion heaters are working correctly. They should be controlling the water temperature between 55°C and 60°C.
3. Make sure the pressure in the expansion vessel is set to 3 bar. This is done by turning off the water supply to the unit and opening a hot tap first. Air or CO<sub>2</sub> can be used for repressuring the expansion vessel.
4. Remove the head on the inlet control set and clean the mesh filter within.
5. Update the benchmark service record supplied after every service by the installer.

## DISCHARGE AT THE TUNDISH

**IF WATER IS FLOWING THROUGH THE TUNDISH THIS INDICATES DISCHARGE FROM ONE OF THE SAFETY VALVES AND INDICATES A FAULT IN THE SYSTEM. CONTACT A COMPETENT PLUMBER OUT TO SERVICE OR DIAGNOSE THE SYSTEM.**



## CYLINDER FAULT FINDING

PROBLEM	POSSIBLE CAUSE	REMIADIATIVE ACTION
Water is visible at tundish	Potential discharge from T&P valve	Follow tundish/T&P fault finding
	Potential discharge from Expansion relief valve due to fault at PRV	Follow inlet control set fault finding
	Back pressure from system	Check all cold connections into mixer outlets are fed from the balanced cold service from the inlet control valve. If not, additional PRV's must be fitted.
Expansion relief valve opens when cylinder is heated	Possible fault at Expansion Vessel	Follow expansion vessel fault finding
Cylinder appears to be leaking from inside the steel case	Loose cylinder connection - notably from hot water outlet	Check all connection points including the immersion heaters and the hot outlet to ensure that these are not leaking, and remake joints if necessary.
Noise when operating tap or shower	Vibrating/insecure pipework	Ensure that all pipework is secured to the wall with pipe clips as appropriate.
Reduced water flow	Possible external water works being carried out	Check with local authorities and wait for works to be completed
	Lodged debris from mains at Inlet control set or PRV sticking	Strip & clean PRV/inline filter, or replace inlet control set.
No hot water available	Possible immersion heater failure	Follow immersion heater fault finding

## EXPANSION VESSEL FAULT FINDING

PROBLEM	POSSIBLE CAUSE	REMIADIATIVE ACTION
Discharge of water from relief valve into tundish	Expansion Vessel is undersized	Vessel needs resizing and installing by a qualified heating engineer.
	Pre-charge set incorrectly on vessel installation	Pre-charge requires setting when the system is depressurised according to manufacturer's recommendations.
	Vessel membrane is ruptured and may require replacement	Check schrader valve for leaks or damage. Replace vessel if necessary
	Membrane may be partially depressurised due to losses over time and require re-pressurisation	Check schrader valve for leaks or damage. Have heating system serviced and vessel repressurised or replaced.
Leak from flange or water connection	Failure of flange plate	Replace flange plate or entire vessel
	Ruptured membrane has led to internal corrosion and has caused leak in vessel	Replace entire vessel
Vessel appears full of liquid when system is cold	Membrane is fully depressurised	Replace membrane or entire vessel. Check schrader valve for leaks or damage.
Water discharges from vessel when schrader pin is depressed for inspection of pressure	Vessel membrane is ruptured	Replace membrane or entire vessel.

## INLET CONTROL GROUP - FAULT FINDING

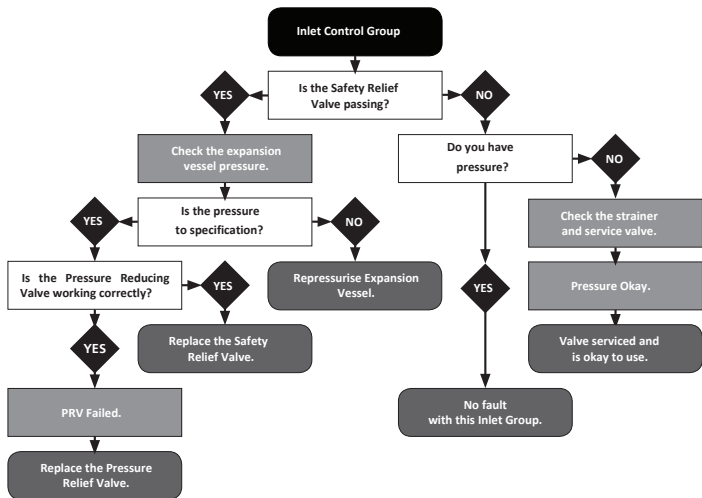

## TUNDISH - FAULT FINDING

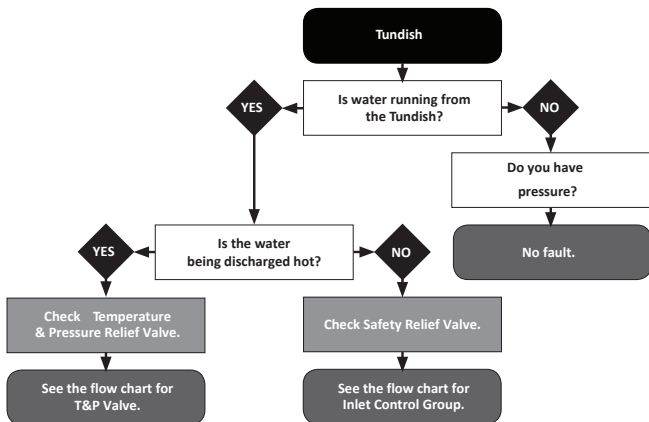

## T&P VALVE - FAULT FINDING

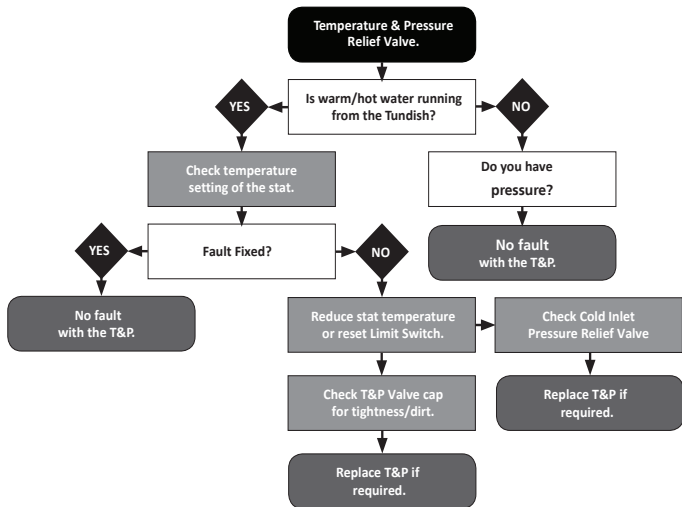

## IMMERSION HEATER - FAULT FINDING

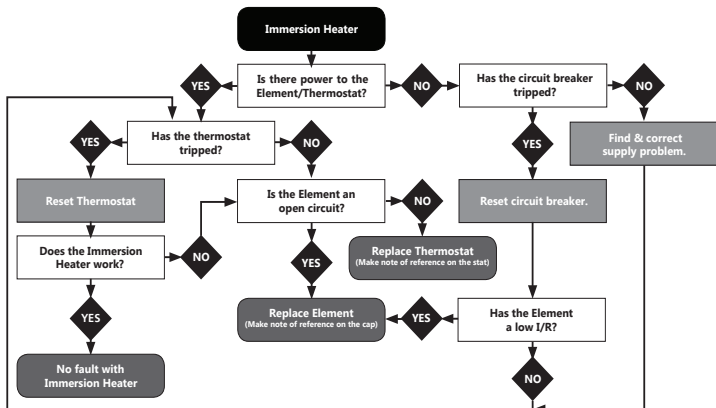

## MAINS PRESSURE HOT WATER STORAGE SYSTEM COMMISSIONING CHECKLIST

This Commissioning Checklist is to be completed in full by the competent person who commissioned the storage system as a means of demonstrating compliance with the appropriate Building Regulations and then handed to the customer to keep for future reference.

Failure to install and commission this equipment to the manufacturer's instructions may invalidate the warranty but does not affect statutory rights.

Customer name:										Telephone number:														
Address:																								
Cylinder Make and Model																								
Cylinder Serial Number																								
Commissioned by (PRINT NAME):										Registered Operative ID Number														
Company name:										Telephone number:														
Company address:																								
										Commissioning date:														
To be completed by the customer on receipt of a Building Regulations Compliance Certificate*:																								
Building Regulations Notification Number (if applicable)																								
<b>ALL SYSTEMS PRIMARY SETTINGS</b> (indirect heating only)																								
Is the primary circuit a sealed or open vented system?										Sealed					Open									
What is the maximum primary flow temperature?															°C									
<b>ALL SYSTEMS</b>																								
What is the incoming static cold water pressure at the inlet to the system?															bar									
Has a strainer been cleaned of installation debris (if fitted)?										Yes					No									
Is the installation in a hard water area (above 200ppm)?										Yes					No									
If yes, has a water scale reducer been fitted?										Yes					No									
What type of scale reducer has been fitted?																								
What is the hot water thermostat set temperature?															°C									
What is the maximum hot water flow rate at set thermostat temperature (measured at high flow outlet)?															l/min									
Time and temperature controls have been fitted in compliance with Part L of the Building Regulations?										Yes					No									
Type of control system (if applicable)										Y Plan					S Plan					Other				
Is the cylinder solar (or other renewable) compatible?										Yes					No									
What is the hot water temperature at the nearest outlet?															°C									
All appropriate pipes have been insulated up to 1 metre or the point where they become concealed										Yes					No									
<b>UNVENTED SYSTEMS ONLY</b>																								
Where is the pressure reducing valve situated (if fitted)?																								
What is the pressure reducing valve setting?															bar									
Has a combined temperature and pressure relief valve and expansion valve been fitted and discharge tested?										Yes					No									
The tundish and discharge pipework have been connected and terminated to Part G of the Building Regulations										Yes					No									
Are all energy sources fitted with a cut out device?										Yes					No									
Has the expansion vessel or internal air space been checked?										Yes					No									
<b>THERMAL STORES ONLY</b>																								
What store temperature is achievable?															°C									
What is the maximum hot water temperature?															°C									
<b>ALL INSTALLATIONS</b>																								
The hot water system complies with the appropriate Building Regulations										Yes					No									
The system has been installed and commissioned in accordance with the manufacturer's instructions										Yes					No									
The system controls have been demonstrated to and understood by the customer										Yes					No									
The manufacturer's literature, including Benchmark Checklist and Service Record, has been explained and left with the customer										Yes					No									
Commissioning Engineer's Signature																								
Customer's Signature																								
(To confirm satisfactory demonstration and receipt of manufacturer's literature)																								

\*All installations in England and Wales must be notified to Local Authority Building Control (LABC) either directly or through a Competent Persons Scheme. A Building Regulations Compliance Certificate will then be issued to the customer.

## SERVICE RECORD

It is recommended that your hot water system is serviced regularly and that the appropriate Service Record is completed.

### Service Provider

Before completing the appropriate Service Record below, please ensure you have carried out the service as described in the manufacturer's instructions.

<b>SERVICE 01</b>	Date:	<b>SERVICE 02</b>	Date:
Engineer name:		Engineer name:	
Company name:		Company name:	
Telephone No:		Telephone No:	
Comments:		Comments:	
.....		.....	
.....		.....	
.....		.....	
Signature		Signature	
<b>SERVICE 03</b>	Date:	<b>SERVICE 04</b>	Date:
Engineer name:		Engineer name:	
Company name:		Company name:	
Telephone No:		Telephone No:	
Comments:		Comments:	
.....		.....	
.....		.....	
.....		.....	
Signature		Signature	
<b>SERVICE 05</b>	Date:	<b>SERVICE 06</b>	Date:
Engineer name:		Engineer name:	
Company name:		Company name:	
Telephone No:		Telephone No:	
Comments:		Comments:	
.....		.....	
.....		.....	
.....		.....	
Signature		Signature	
<b>SERVICE 07</b>	Date:	<b>SERVICE 08</b>	Date:
Engineer name:		Engineer name:	
Company name:		Company name:	
Telephone No:		Telephone No:	
Comments:		Comments:	
.....		.....	
.....		.....	
.....		.....	
Signature		Signature	
<b>SERVICE 09</b>	Date:	<b>SERVICE 10</b>	Date:
Engineer name:		Engineer name:	
Company name:		Company name:	
Telephone No:		Telephone No:	
Comments:		Comments:	
.....		.....	
.....		.....	
.....		.....	
Signature		Signature	

## **GUARANTEE AND EXEMPTIONS**

The cylinder carries a 25-year guarantee against faulty materials or manufacturing, based upon the following conditions:

- Correct installation as per this document and all relevant standards, regulations, and codes of practice in force at the time.
- The Benchmark Commissioning Checklist has been completed
- The unit has been serviced annually.
- The product has not been modified in any way, other than by us.
- There has not been any misuse, tampering, or neglect of the cylinder.
- It has only been used for the storage of potable water
- It has not been subjected to frost damage
- The system is fed from a public mains water supply
- Storage temperatures have not exceeded 65°C
- Installations made only in the United Kingdom.
- The water chemistry used in the system is found to be above the maximum allowances.
- Units are not installed with uncontrollable heat sources (e.g. wood burning stoves)
- For commercial or heavy-duty installations where constant usage and reheating is required, titanium immersion heaters must be fitted to comply with the warranty
- The guarantee period starts from the date of purchase.
- The extended guarantee is not transferable and rests with the original householder.

## **EXCLUSIONS**

- The effect of scale build-up on the unit or its components
- Any labour charges associated with replacing the unit or its parts
- Any consequential losses caused by the failure or malfunction of the unit.

Note: Invoices for servicing may be requested to prove that the unit has been serviced annually. All the components fitted to/or supplied with the cylinder carry a 2-year guarantee. The guarantee starts when the cylinder is first filled.

## **CLAIMS**

**On the rare occasion of a fault occurring, we will only consider sensible claims that are submitted in full at the time when the faulty part/unit is returned to us.**

**We will not cover any installer claims for excessive travelling where the installer has accepted a job more than 30 miles from their base of operations.**

**Removal costs cannot be recovered for the collection of a faulty unit from a difficult to reach area or where cylinder access has been restricted (as per this manual guidance.)**

**Claims will not be accepted for units that have not been installed in accordance with this manual.**

## **PROBLEM GUIDANCE**

When a problem arises, your first point of contact is the plumber who fitted the unit (in the first year), followed by the plumber who carries out the annual servicing of your unit for you.

If your cylinder begins to leak, we will supply you with a new one. To prevent fraud, we request an up-front payment in this case while we establish the cause of the fault. The original unit must be returned to us for inspection along with a copy of your service record and commissioning checklist. Your upfront payment will be refunded as soon as it is confirmed that the cylinder has failed within the terms of our warranty.

If a component part fails within the two-year guarantee, we will send you a new one with an upfront charge. Your credit card details may be required to prevent fraud. We ask you to post the faulty part back to us by recorded delivery within a month. A refund will be issued once the part has been tested and proven to be at fault.

## **APPENDIX - WATER CHEMISTRY**

This water heater is manufactured to suit the water conditions of most public reticulated water supplies. However, there are some known water chemistries which can have detrimental effects on the cylinder. If you are unsure of your water chemistry, you may be able to obtain the relevant water chemistry information from your local water supply authority.

\*Our warranty will not apply where water stored in the storage cylinder exceeds at any time any of the following levels: - TOTAL HARDNESS 200mg/L, TOTAL DISSOLVED SOLIDS 600mg/L

**SPARE PARTS**

<b>MODEL</b>	<b>DESCRIPTION</b>	<b>Part Code</b>
STEELFLOW	22MM INLET CONTROL GROUP VALVE 3 BAR/6 BAR	SFWUVPR
STEELFLOW	1/2" T&P RELIEF VALVE 7BAR/90 DEG	SFWUVTP7
STEELFLOW	12 LITRE POTABLE EXPANSION VESSEL	SFWU12EV
STEELFLOW	18 LITRE POTABLE EXPANSION VESSEL	SFWU18EV
STEELFLOW	24 LITRE POTABLE EXPANSION VESSEL	SFWU24EV
STEELFLOW	35 LITRE POTABLE EXPANSION VESSEL	SFWU35EV
STEELFLOW	15MM/22MM TUNDISH	SFWUTUND
STEELFLOW	MECHANICAL DUAL CYLINDER STAT	SFWUEDAC
STEELFLOW	22MM 2 PORT ZONE VALVE	SUWUEMZV
STEELFLOW	1 3/4" 3KW INCOLOY IMMERSION HEATER	SFWUEIHS











**McDonald Water Storage**

Queensway Industrial Estate, Glenrothes, Fife,  
Scotland, KY7 5QF

Tel: **01592 611123** Email: **[sales@mcdonaldwaterstorage.com](mailto:sales@mcdonaldwaterstorage.com)**