



McDonald
Water Storage

CUBEflow

Thermal Store Tank Installation & Technical Manual



Tel: (01592) 611123

www.mcdonaldwaterstorage.com

November 2020

CUBEflow Thermal Store Tank, Installation & Technical Manual

Manual must be completed by Installer and left with Home Owner

Contents

Preface	2
Handling & Storage	2
What is a Thermal Store?	3
Design	3
Mains Water Supply	4
Immersion Heaters	4
Water Treatment	5
Pipework	6
Discharge/Overflow Requirements	6
Showers	7
Coral E: General Schematic.....	8
Coral E: Description & Heights.....	9
Coral Si: General Schematic.....	10
Coral Si: Description & Heights.....	11
Technical Data	12
CUBE <i>flow</i> Thermal Store with External PHE: Description	13
CUBE <i>flow</i> Thermal Store with External PHE: Wiring Diagram.....	13
CUBE <i>flow</i> Thermal Store with External PHE: General Schematic	14
Installation Schematic (Coral E)	15
Installation Schematic (Coral Si)	16
Commissioning	17
Troubleshooting.....	19
Warranty.....	20
Ancillary Descriptions	22
Commissioning Checklist	24

Preface

An early adopter of the principal of domestic thermal stores, McDonald Water Storage first started manufacturing thermal stores in early 1990s. Manufactured by our trained coppersmiths and designed based upon the experiences of our technical team. The McDonald Water Storage CUBE*flow* provides the perfect solution to both mains pressure hot water and, in the case of the **Coral Si** model, space heating requirements, whilst contained within a boxed-in design.

The CUBE*flow* Thermal Store Technical Manual should be read in conjunction with the installation and servicing manuals issued by the manufacturer(s) of the heat source(s) used within the thermal storage system.

This information provided is intended to provide support with the installation of the CUBE*flow* thermal storage system. Responsibility for selection and specification of our equipment remains that of our customer and any experts or consultants concerned with the installation(s). Our full Terms & Conditions of Sale are available on request.

The CUBE*flow* thermal storage system is required to be fitted by a competent installer, in accordance with **Building Regulations G**, **Gas Safety Regulations**, and the **Water Fitting Regulations (England and Wales)**, **Water Fitting Regulations (Northern Ireland)** or **Water Byelaws (Scotland)**.

(Please note that while the CUBE*flow* overcomes Safety implications within **Building Regulations G3** relating to pressure and temperature discharge requirements, the installation of the CUBE*flow* may be notifiable to the relevant building control.)

Handling & Storage

It is important the CUBE*flow* is handled with care and stored the correct way up in a dry place at all times prior to, during and after installation.

Carrying handles are provided in the back of the casing to assist with lifting and positioning. **DO NOT LIFT BY THE PIPEWORK** as this can loosen off the pre-tested pipework and may result in leaks. It is good practice to check the joints before filling with water in case anything has been loosened in transit. Any manual lifting will need to comply with the requirements of the Manual Handling Operations Regulations issued by the Health & Safety Executive. For installations on higher levels of properties such as the 4th floor it is recommended as best practice for the CUBE*flow* to be moved vertically within a lift.

What is a Thermal Store?

- Initially the Thermal Store is filled through the ball-valve that is sited in the feed and expansion tank to the cold working level. This primary water stays within the unit.
- The primary store of water is then heated directly via the use of immersion heaters, or indirectly from a boiler or central plant.
- The hot water is generated via a secondary heat exchanger that draws its heat from the primary store of water.

Design

The copper CUBEflow Rectangular Thermal Store is a bespoke primary store that is very well insulated to ensure minimum Heat Loss and optimally designed to meet the stringent requirements of ERP. In addition, being a rectangular tank means that it will hold 25% more water than a cylinder in a given space, and that the dimensions can be altered to make the best use of the available space.

Cold water at mains pressure passes through a High Efficiency Coil, which is specifically designed to draw heat from the thermal store at mains pressure. This heated water is subsequently blended with cold mains water through a Thermostatically Controlled Mixing Valve, to provide mains pressure water at 55°C to the taps and showers.

The Secondary Pipework Loop (DHW Coil & External Pipework) can contain a total of **3 - 5 Litres** of water, and incorporates an expansion bottle to accommodate the thermal expansion of the heated mains water. If the volume of the secondary pipework loop **exceeds 15 Litres**, then the installer must fit suitable relief valves and appropriately sized expansion vessels.

In addition, in smaller properties if required, the **Coral Si** model can allow the primary water contained within the store can also be circulated around the heating system allowing the householder to enjoy the benefits of mains pressure water and heating.

Being a thermal store that is vented, it is inherently safe and requires no annual maintenance. Its benefits go one step further as being a primary store there is no legionella risk, and having a blending valve ensures in-built scald protection.

Mains Water Supply

- The mains supply to the unit should ideally be in a minimum of **22mm diameter** but will work with 15mm if there is adequate pressure and flow rate.
- The CUBEflow will operate with a minimum incoming mains pressure of **1.0 Bar** and a **minimum flow rate of 20 Litres/minute**. Careful consideration should be made to ensure the pressure of hot and cold supplies are balanced.
- An incoming pressure of **2.1 Bar** is the most optimal for performance.
- If the incoming pressure **exceeds 3 Bar**, then a pressure reducing valve must be fitted after the stopcock of where the incoming cold supply enters the property.
- No Pressure Reducing Valve or Check Valve should be fitted **within 2 metres** of the Cold Inlet to the CUBEflow Coil.
- If the flow rate exceeds **18 Litres per minute** at any tap, it should be restricted to maintain the performance of the system as a whole.

Immersion Heaters

- Immersion Heaters should be set to ensure the reading on the Thermometer reaches **75°C** (maximum **80°C**) once the unit is heated.
- We would recommend setting the Immersion Heaters at **70°C** and the high limit at **90°C**. This can be lowered or increased as required for the installation requirements.
- If in any doubt of how to set the Immersion or what temperature we would advise for specific installations, please contact us on **01592 611123**.
- All Immersion Heaters should be wired by a qualified electrician as shown below;

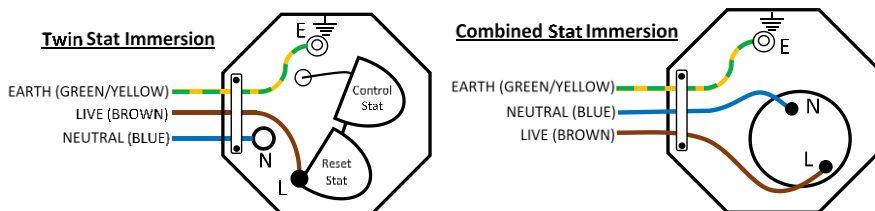

Water Treatment

In accordance with the **Building Regulations L1A: New Dwellings/ L1B: Existing Dwellings**, the requirements set out in the **Domestic Building Services Compliance Guide** specify that “where the mains water hardness exceeds 200ppm provision should be made to treat the feed water to water heaters and the hot water circuit of combination boilers to reduce the rate of accumulation of lime scale”. In most instances of this water condition, an inline Water Conditioner/Scale Inhibitor would be fitted to the incoming mains.

The water quality shall be in accordance with **European Council Directive 98/83/EC**, or revised version at the date of installation, and is not fed with water from a private supply. Particular:

- Chloride content: Max. 200 mg/l
- Sulphate content: Max. 200 mg/l
- Combination chloride/sulphate: Max. 300 mg/l (in total)

The CUBE*flow* is part of the primary system and while the **Coral E** models do not require any special water treatment we do recommend adding inhibitor. The **Coral Si** models and other parts of the primary circuit will require the application of a protective scale and corrosion inhibitor such as Fernox to ensure adequate protection. This should avoid having corrosive material in the primary system and remove any build-up of sludge which can reduce the performance of the High Efficiency Heat Exchanger Coil.

The volumes and concentration of inhibitor required should be calculated in accordance with the manufacturer’s instructions. Please ensure that the thermal store volume is also included as well as the radiator and pipework volume.

An inhibitor is optional for the **Coral E** models. However if there are doubts regarding the quality of water being used to fill the CUBE*flow*, an inhibitor should be added to the appliance when filling in line with the manufacturer’s instructions for these products.

Please note that in all CUBE*flow* models, the primary water within the thermal store water is used as primary storage and the domestic hot water is heated instantaneously by means of the High Efficiency Heat Exchanger Coil. Therefore, treating the primary water will not have an effect on the domestic hot water supply.

Pipework

It is imperative to achieve balanced supply of hot and cold water in a mains pressure system, and that the piping in a dwelling should be sized in accordance with **BS 6700**.

However, the following rule of thumb guide lines should be adequate for most of the smaller property types as long as water pressures are within the recommended range.

- The cold feed from the main incoming stop tap to the CUBEflow should be run in **22mm** pipe. The cold main and hot draw-off should also be run in **22mm** as far as the branch to the bath tap.
- A **15mm** copper or equivalent external service may be sufficient for a small 1 bathroom dwelling (depending upon the flow rate available), but the minimum recommended size for new dwellings is **22mm** (25mm MDPE).
- The internal branches to the hand basins and sinks should be in **10mm** and to the baths and showers in **15mm**. (1 metre minimum)
- A pressure reducing valve must be fitted after the stopcock of where the incoming cold supply enters the property and at least 2 metres from the unit.

Discharge/Overflow Requirements

The CUBEflow is a Vented Thermal Store and therefore does not require safety discharge from a Pressure and Temperature Relief Valve as highlighted in Part G of the Building Regulations.

The **Manual Fill** version of the CUBEflow Thermal Store can be sited anywhere within the property as no discharge pipework is required, however we do supply an Overflow pipe to the Feed & Expansion tank. (On the **Coral Si** model, if an open vented central heating is to be run minimum **500mm** from the highest point of the radiator circuit and the bottom of the Feed & Expansion Tank.) Once the unit is filled through the pipework, close off the isolation valve and disconnect the flexible hose from the pipework and cap the pipe to avoid any dead legs.

If an **Automatic Fill** version is to be installed then the overflow must be run to a suitable drain point. A site glass can be supplied if the overflow termination is difficult to see. The site glass must be fitted **vertically**, with continuous fall of the overflow pipe.

The overflow should be run in either 22mm copper tube or high temperature overflow pipe with suitable supports. Ensure that the overflow is capable of coping with a ball-valve fail situation and restrict flow to the ball-valve accordingly.

Showers

- CUBEflow is compatible with all showers.
- Most commonly used are of the Thermostatic Mixing type. All mains pressure systems are subject to dynamic changes particularly when other hot and cold taps/showers are opened and closed. This will cause changes in the inlet hot water temperature and pressure at mixed water outlets such as showers.
- Careful consideration should be taken in selecting specification of the shower valve to ensure the correct mixed water temperature and pressure is maintained and that it is suitable for the type of people using it.
- Some showers in the TMV2 range have about a 10 degree differential between the hot inlet temperature and the mixed outlet temperature, allowing showering temperatures of up to 48 degrees.
- Other valves such as TMV3 only allow maximum temperatures of 41 degrees.
- Commissioning should ensure that the hot draw off from the thermal store is set taking this into account.
- Please ensure that the shower head is capable of taking mains pressure.
- Please ensure that the shower tray drain is capable of handling the shower head flow rate. A flow restrictor may be required in the shower outlet hose.
- The hot water supply to a shower-mixing valve should be fed wherever practical directly from the CUBEflow or be the first draw-off point on the hot circuit.
- The cold supply to a shower-mixing valve should wherever practical be fed directly from the incoming mains. To ensure balanced pressure for the shower mixing valve, a pressure reducing valve must be fitted after the stopcock of where the incoming cold supply enters the property.
- The shower must incorporate or be fitted with the necessary check valves to provide back-syphonage protection in accordance with the Water Regulations.

Coral E: General Schematic

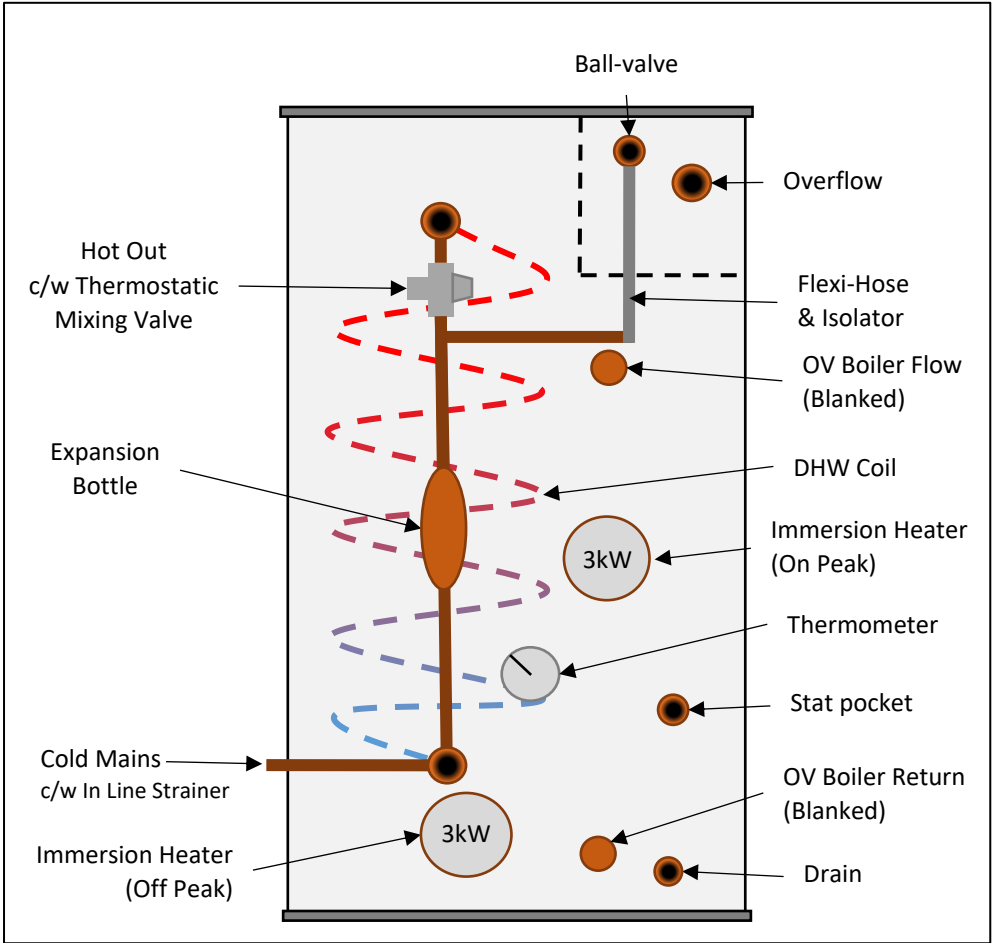

Coral E: Description & Heights

The Coral E CUBEflow is the electrically heated Thermal Store tank. This unit is suitable for use with off peak electricity tariffs, such as Economy 7 and Economy 10.

The standard brochure sized unit connection heights shown below are taken from the ground (in mm). These heights and the diagrams shown above are indicative of a typical arrangement of connections, including optional extras. **Bespoke options for specific installation are available and will be supplied with a sketch prior to manufacturing of the CUBEflow Thermal Store.**

Capacity (Litres)	100	150	210	250	300
Depth (mm)	570	570	570	600	640
Width (mm)	495	495	585	600	640
Height (mm)	865	1285	1285	1260	1285
Drain	60	60	60	60	60
Off Peak Immersion	115	115	115	115	115
On Peak Immersion	435	645	645	630	645
Thermometer	265	265	265	265	265
Ball-valve	800	1220	1220	1195	1220
Overflow	780	1200	1200	1175	1200
Hot Out (Coil)	645	1065	1065	1040	1065
Cold In (Coil)	165	300	300	300	300
OV Boiler Flow (BI)	500	840	840	815	840
OV Boiler Return (BI)	65	65	65	65	65
Stat Pocket	180	270	270	270	270

Allow 100mm clearance on any face of the unit with pipework / connections and allow 225mm between the top of the tank and ceiling to allow access to service the ball-valve if ever required.

Coral Si: General Schematic

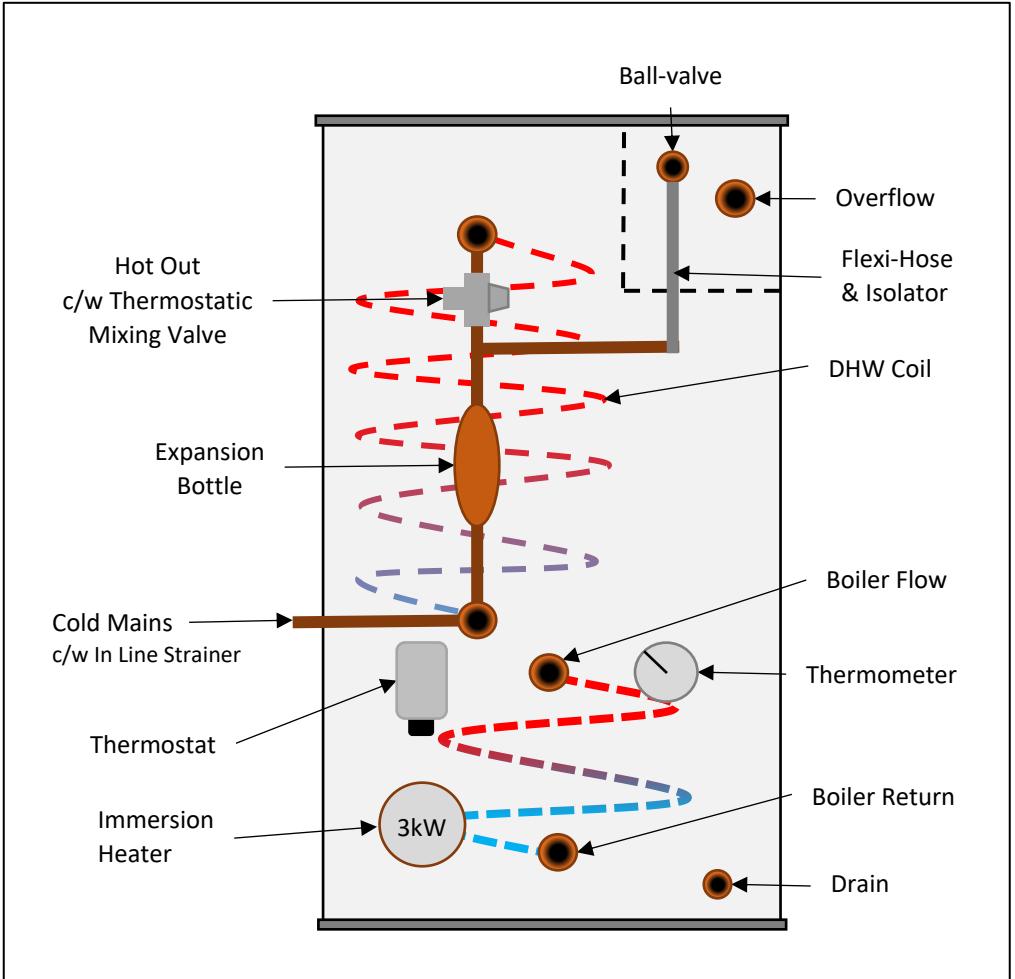

Coral Si: Description & Heights

The Coral Si CUBEflow is the indirectly (Boiler) heated Thermal Store tank. This unit is suitable for use with different heat sources including Boiler, Solid Fuel and Electric.

The standard brochure sized unit connection heights shown below are taken from the ground (in mm). These heights and the diagrams shown above are indicative of a typical arrangement of connections, including optional extras. **Bespoke options for specific installation are available and will be supplied with a sketch prior to manufacturing of the CUBEflow Thermal Store.**

Capacity (Litres)	150	210	250	300
Depth (mm)	570	570	600	640
Width (mm)	495	585	600	640
Height (mm)	1285	1285	1260	1285
Drain	60	60	60	60
Immersion	115	115	115	115
Boiler Flow	265	265	265	265
Boiler Return	65	65	65	65
Thermostat	265	265	265	265
Thermometer	265	265	265	265
Ball-valve	1220	1220	1195	1220
Overflow	1200	1200	1175	1200
Hot Out (Coil)	1065	1065	1040	1065
Cold In (Coil)	485	485	460	485

Allow 100mm clearance on any face of the unit with pipework / connections and allow 225mm between the top of the tank and ceiling to allow access to service the ball-valve if ever required.

Technical Data

ERP / Heat Loss Data

Capacity (Litres)	100	150	210	250	300
Insulation Thickness (mm)	50	50	50	50	50
ERP Class	C	C	C	C	C
Standing Heat Loss (Watts)	59	68	78	85	94
Standing Heat Loss (kWh/day)	1.42	1.63	1.87	2.04	2.26
Draw Off Profile*	M	M	L	L	L
Annual Energy Consumption (kWh)*	1489	1974	2813	3172	3374
Annual Energy Consumption (GJ)*	5	7	10	11	12
dB Rating*	15	15	15	15	15

*Coral E only

Thermal Store CUBEflows have been tested in accordance with EN 50440 (Coral E) or HWA Thermal Store Specification (Coral Si). Heat losses should not be directly compared with heat losses from unvented/vented tanks, because unvented/vented tanks are tested at 65°C and thermal stores at 75°C, so they are treated differently in SAP.

Draw Off Profile (L)

Capacity	@50°C	@45°C	@40°C
100	75	95	110
150	113	143	165
210	158	200	231
250	188	238	275
300	225	285	330

- Store Temperature - 75°C
- Incoming Mains - 10°C
- Ambient Temperature - 20°C
- Tap Flow Rate - 12L/min

Selection Chart

Capacity (Litres)	Width (mm)	Depth (mm)	Height (mm)	Heat Loss (kwh/24hrs)	Property Type
100	570	495	865	1.42	1 Bed with shower
150	570	495	1285	1.63	1 – 2 Bed, bathroom/en suite shower
210	570	585	1285	1.87	2 – 3 Bed, bathroom & en suite shower
250	600	600	1260	2.04	3 – 4 Bed, bathroom & en suite shower
300	640	640	1285	2.26	3 – 4 Bed, 2 bathrooms & en suite shower

CUBEflow Thermal Store with External PHE: Description

An External Plate Heat Exchanger (PHE) can be fitted to a CUBEflow in replacement of the internal High Efficiency Coil. This is an ideal solution in areas with hard water or limescale, and is easier to clean or replace the PHE as required.

The cold mains is fed through the Secondary side of the PHE, whilst the primary water in the thermal store, is pumped through the Primary side. A flow switch on the Secondary pipework, when activated by a hot outlet being opened, will activate the Charging Pump to circulate the store's water round the PHE, allowing for instantaneously heated water. Both the Pump and Switch are linked through a Wiring Centre, installed on the side of the tank.

CUBEflow Thermal Store with External PHE: Wiring Diagram

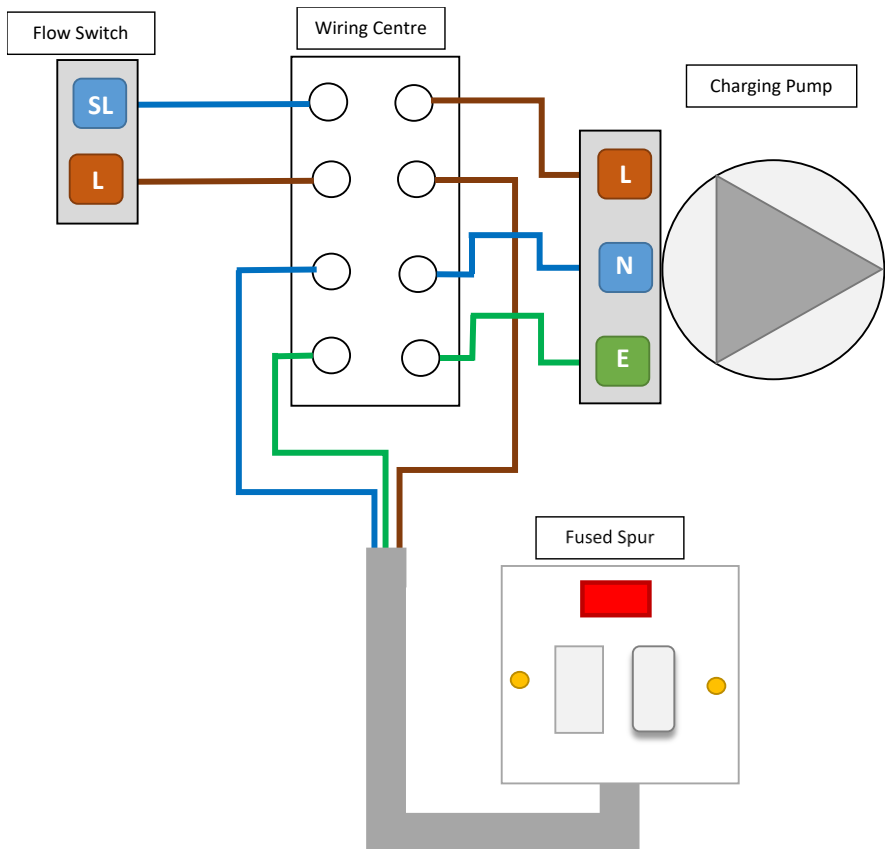

CUBEflow Thermal Store with External PHE: General Schematic

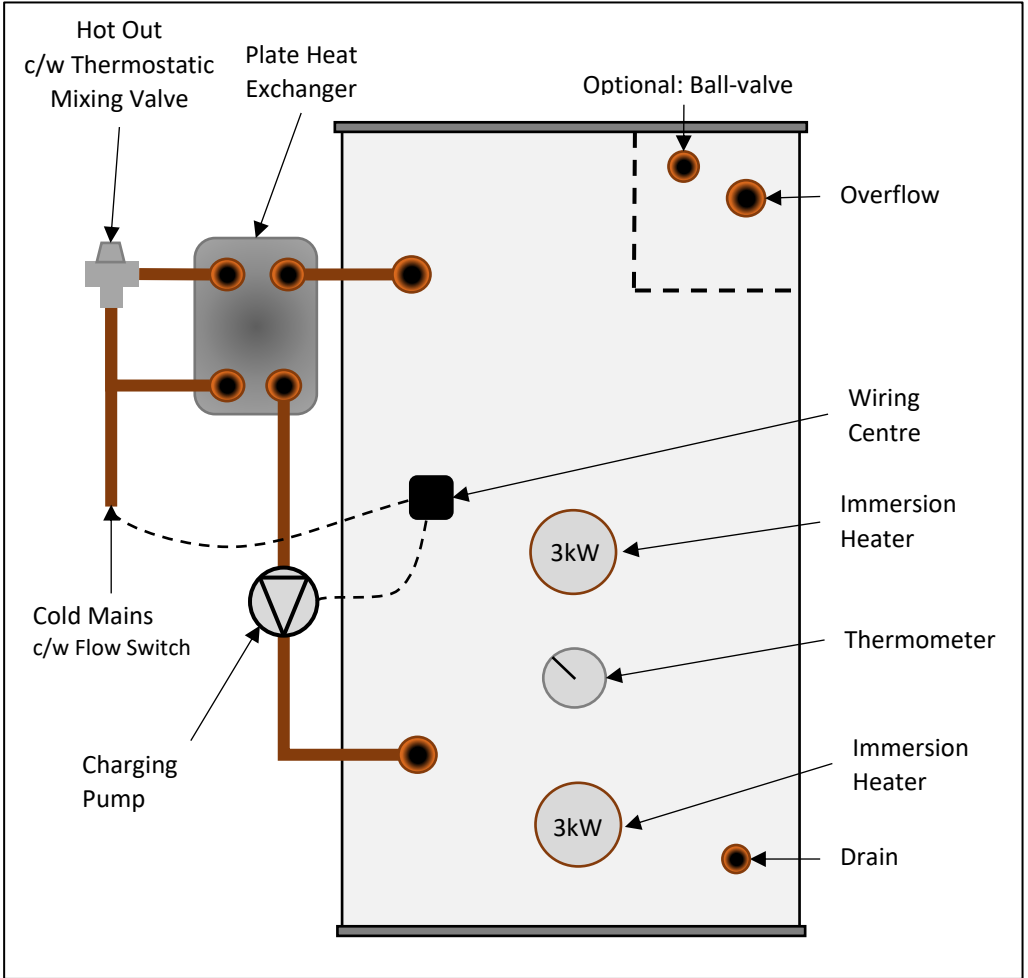

Installation Schematic (Coral E)

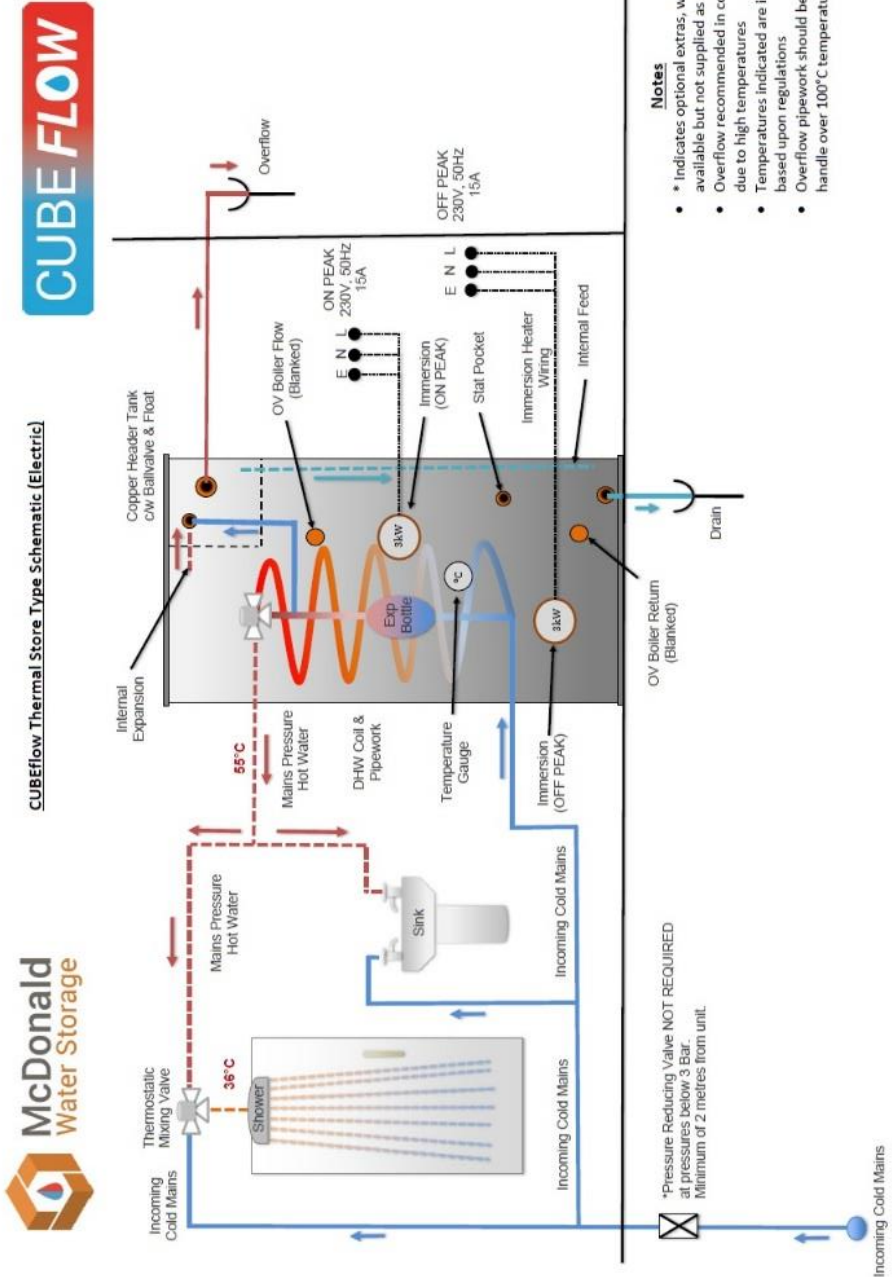

Installation Schematic (Coral Si)



CUBEflow Thermal Store Type Schematic (Indirect)

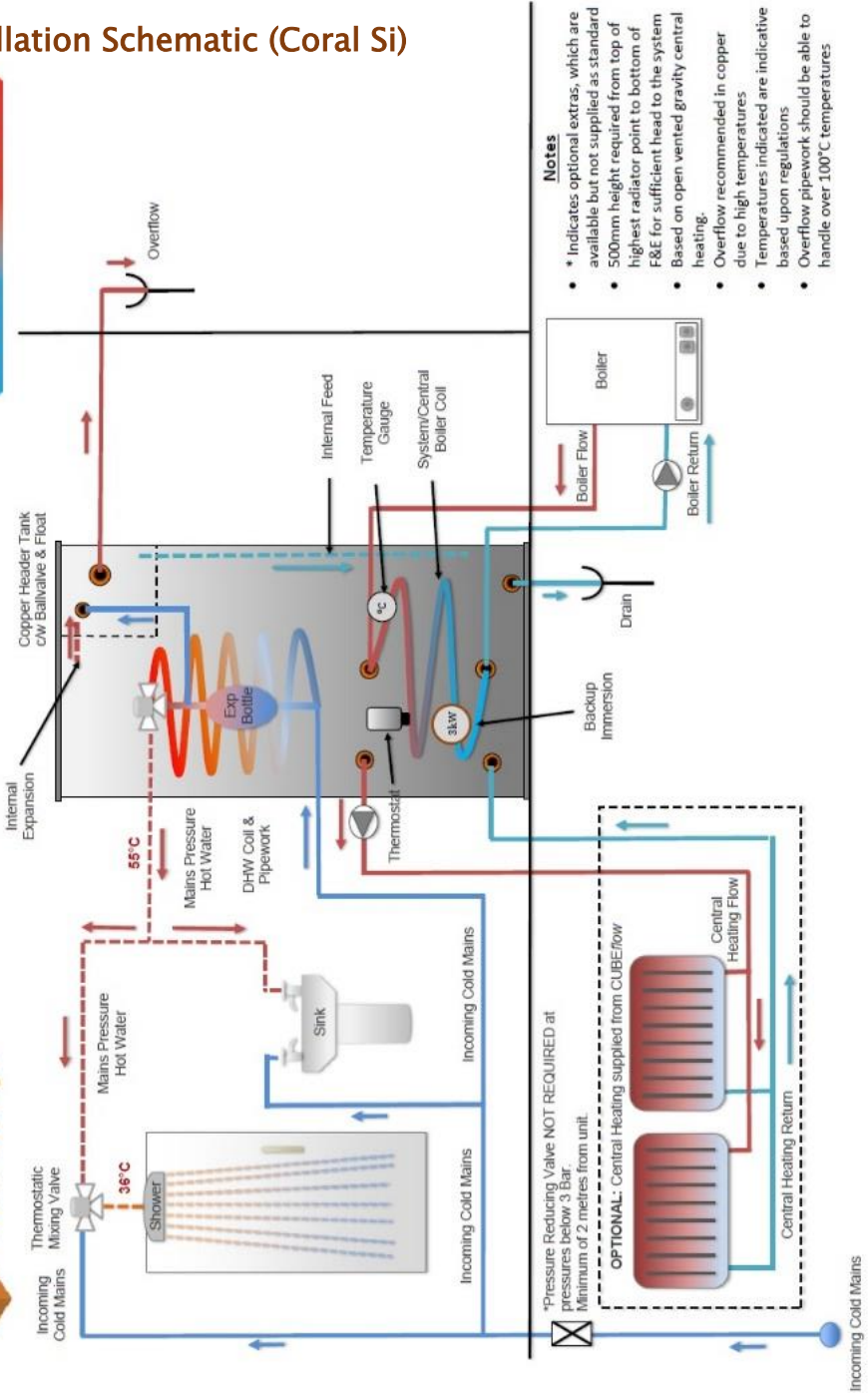

Notes

- * Indicates optional extras, which are available but not supplied as standard
- 500mm height required from top of highest radiator point to bottom of F&E for sufficient head to the system
- Based on open vented gravity central heating.
- Overflow recommended in copper due to high temperatures
- Temperatures indicated are indicative based upon regulations
- Overflow pipework should be able to handle over 100°C temperatures

*Pressure Reducing Valve NOT REQUIRED at pressures below 3 Bar. Minimum of 2 metres from unit.

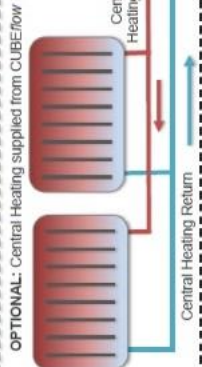

Incoming Cold Mains

Commissioning

The below is a recommended guide of actions and checks that should be undertaken during commissioning:-

DO

- ✓ **During commissioning, complete all relevant sections of the Commissioning Checklist (Page 22-24). This must be completed during commissioning and left with product to meet the Warranty conditions.**
- ✓ Check the incoming mains water pressure. If the incoming mains pressure is higher than **3.0 Bar**, fit a Pressure Reducing Valve set at 3.0 Bar maximum – recommended **2.1 Bar** where the cold supply enters the property as this will create balanced pressure throughout.
- ✓ Ensure that connections are fitted in accordance with the sketch supplied
- ✓ Ensure the drain is connected to allow draining of the unit if required. If a drain-cock is fitted, we recommend a DZR fitting.
- ✓ Fit the Overflow with Copper piping or high temperature plastic to the thermal store system where required.
- ✓ Allow 100mm clearance on any face of the unit with pipework / connections and allow 225mm between the top of the tank and ceiling to allow access to service the ball-valve if ever required.
- ✓ Check that all pipework connections on the *CUBEflow* are tight with pipes fully inserted following transit and handling.
- ✓ Fill the *CUBEflow* via the ball-valve in Feed & Expansion Tank
- ✓ Ensure the system is inhibited correctly – see page 5.
- ✓ Check the water level in the Feed & Expansion Tank, and adjust ball-valve so water is at lowest level.
- ✓ On the **Automatic Fill** version, turn down servicing valve once system is initially filled to where the warning/overflow pipe will cope with the discharge from a ball-valve failure.
- ✓ On the **Manual Fill** version, once the unit is filled through the pipework, close off the isolation valve, disconnect the flexible hose from the pipework and cap the pipe to avoid any dead legs.
- ✓ Check for leaks throughout the thermal storage system.
- ✓ Run all taps and other hot outlets to remove all air from the system.
- ✓ Ensure the store temperature is set to circa 75°C on the store temperature gauge. This can be increased but consideration should be made for the temperature and pressure rise, caused by “creeping”, where small draw offs are present.

- ✓ Electric only - Immersion Heaters should be set at 70°C to meet users' hot water requirements – see page 4.
- ✓ Domestic Boilers – Set the boiler pump to its highest setting. Set the Boiler Thermostat and also the CUBEflow thermostat to maximum. Fire the boiler on HOT WATER ONLY setting and wait until the boiler goes off. Turn the cylinder thermostat down slowly till it clicks off, then turn it down by approximately 2°C. This should mean that the CUBEflow thermostat controls the system. This can be checked by running off some of the hot water, re-firing the boiler and checking that the CUBEflow thermostat is in control.
- ✓ Central Plant Boilers - Where the Coral Si CUBEflow utilises a central plant boiler, the probe thermostat should be set at 65°C, ensuring the central plant boiler is able to achieve the set point. Ensure the 2-port valve switches off when the set point is reached and back on as the unit cools. The setting can be increased if required to suit the hot water usage and application, but ensure the 2-port valve continues to operate correctly at the higher temperature.
- ✓ Temperature Controls must be fitted to ensure safe temperature of Thermal Store
- ✓ Ensure sufficient clearance for External Plate Heat Exchanger & Pipework, if applicable.
- ✓ On installs where central heating is run from the Coral Si CUBEflow, ensure that 500mm height difference is in place between the highest point of the radiator circuit and the bottom of the Feed & Expansion Tank.
- ✓ Ensure that all exposed pipework on the CUBEflow is insulated to minimise any heat losses.
- ✓ Ensure the Thermostatic Mixing Valve is adjusted to control the hot water outlet temperature between 50 - 55°C (take shower differential into consideration).
- ✓ Check the boiler pump setting is set as high as possible without emitting excessive noise to prevent a boiler temperature differential of greater than 11°C.
- ✓ If required, chlorinate the hot and cold water system in accordance with **BS 6700** and Water Regulations. Please note that the whole of the domestic hot and cold water systems must be adequately flushed after chlorination. Failure to do so will cause damage to the exchangers/immersion heaters etc.

DON'T

- ✗ Use a combined feed and vent.
- ✗ Place any clothing or other combustible materials against or on the CUBEflow.

Troubleshooting

Below contains a troubleshooting and solution guide to the thermal store system. If this table does not resolve your problem, please contact either your installer or phone McDonald Water Storage Technical Team for further advice.

SYMPTOM	SOLUTION
<p>The water at the tap is lukewarm or cold.</p>	<p>The thermal store is designed to work best when the store temperature is at or approaching 75°C - 80°C. While the thermal store can provide hot water at lower temperature storage, the available flow rates and volume will be reduced. Check the thermometer is showing the store temperature is at or approaching 75°C - 80°C. If this is not the case;</p> <ol style="list-style-type: none"> 1) On the Coral Si model, ensure that the boiler is firing, that the control thermostat is set at 75°C and allow sufficient time for the store to reach working temperature. 2) On the Coral E model, a qualified electrician should check that the immersion heater is working, the control thermostat is set at 75, the safety cut-out has not tripped, and receiving the correct supply at the correct time (off-peak).
<p>The thermal store is at 75°C and the water at the taps is still lukewarm or cold</p>	<ol style="list-style-type: none"> 1) If the store is at or approaching 75°C - 80°C, check that the Thermostatic Mixing Valve is correctly set. The maximum temperature of water from the Mixing Valve should be about 55°C. 2) If the valve is correctly set, check that the flow rate at any outlet (e.g. bath tap) does not exceed 18 Litres per minute. If the flow rate is too high then sufficient heat transfer inside the CUBEflow may not be occurring. Turn the flow through the tap down or fit a suitable flow restrictor and the temperature will increase. 3) If Stage 1 and 2 has not resolved the problem a competent installer should check the mixing valve for blockages within the internal filter of the mixing valve.
<p>Not enough hot water and less than 75°C on the thermometer.</p>	<p>Check the heat sources and their input in (kW) to the store as this will be lower than the kW output which will result in the store not producing enough heat for the exchanger to provide heated mains pressure water.</p>

<p>There is a brownish tint to the mains pressure hot water.</p>	<p>This could be a symptom with the heat exchanger coil leaking inside the thermal store. An installer should have this tested. If this is the case, pay attention to the Feed & Expansion Tank as the pressure within the store will increase causing the tank to overflow continually.</p>
<p>CUBEflow is set at 75°C but the mains pressure temperature drops quickly when running a tap (e.g. bath)</p>	<ol style="list-style-type: none"> 1) If an inhibitor has been installed, check with the installer that it has been installed at the correct proportion and checked at appropriate frequencies. 2) The in-line strainer in the cold mains supply to the unit may be choked and require cleaning. 3) Carefully check the hot water temperature flow into the mixing valve. If it is very hot, it may be that the valve needs to be checked / replaced. A competent installer should check the mixing valve for blockages within the internal filter. 4) If the DHW Coil is giving an initial heat transfer and then fading, this could be a sign of scale build up inside the Heat Exchanger Coil, especially if in a known hard water area. A competent installer would need to descale the DHW coil and check/fit descaling equipment.

Warranty

McDonald Water Storage guarantee the CUBEflow shell against material defect or manufacturing fault for a period of 5 years from the date of delivery. Components are guaranteed for 2 years.

The above product guarantee is valid provided:

- It has been installed by a competent installer in accordance with the instructions detailed in our installation manual and all relevant Codes of Practice and Regulations in force at the time of installation.
- No factory fitted parts have been removed for unauthorised repair or replacement and the product has not been modified – other than by McDonald Water Storage.
- Any replacement parts should be purchased from McDonald Water Storage.
- The hot water store has only been used for the storage of potable water supplied from the public mains (Max – 200mg/litre chloride). And treated as detailed in the installation instructions.

- The water quality shall be in accordance with **European Council Directive 98/93 EC**, or revised version at the date of installation, and is not fed with water from a private supply. Particular:
 - Chloride content: Max. 200mg/l
 - Sulphate content: Max. 200mg/l
 - Combination chloride/sulphate: Max. 300mg/l (in total)
- It has not been subject to wrong or improper use, left uncared for, or subjected to scale or frost damage.
- In accordance with the **Building Regulations L1A: New Dwellings/ L1B: Existing Dwellings**, the requirements set out in the **Domestic Building Services Compliance Guide** specify that “where the mains water hardness exceeds 200ppm provision should be made to treat the feed water to water heaters and the hot water circuit of combination boilers to reduce the rate of accumulation of lime scale”.
- Where appropriate the unit has been serviced annually by a competent, licenced engineer in accordance with the requirement set out in the installation manual.
- The Commission Checklist Service Record included in our manual has been completed and updated after each annual service where required.
- Any disinfection has been carried out strictly in accordance with **BS 6700**.
- For heavy use installation where constant usage / reheat is required titanium immersion heaters should be fitted.
- Please note, defects caused by corrosion or scale deposits are not covered by any guarantee.
- Without prejudice to any other term, we shall not be liable for any water damage caused directly or indirectly as a result of any leak or other defect in the goods. We cannot control the conditions of use of the goods or the time or manner or location in which they will be installed and the purchaser agrees to be fully responsible for testing and checking all works which include the goods at all relevant times (up to, including and after commissioning) and for taking all necessary steps to identify any leaks and prevent any damage being caused thereby.

Please see our full Terms & Conditions on our website:

<https://www.mcdonaldwaterstorage.com/>









Ancillary Descriptions



The following spare parts are available to purchase from the Website, with additional information provided.

Follow the link below;

<https://www.mcdonaldwaterstorage.com/store/spares>

or phone the office on **(01592) 611123**.

Low Watts Density Immersion Heaters (WIHLWD)	3kW Electric Heating Element for Hot Water Cylinder	
Cylinder Thermostat (WTCT)	THERMflow Thermostat (0 - 90°C)	
Thermostatic Mixing Valve (WTTMV / WTTMVS)	Adjustable Valve top blend hot and cold water feeds.	
Thermometer (W THERM)	2" Dial Thermometer with back entry probe	
Thermal Store Pump (WTP)	Primary Heating System Circulation Pump	
THERMflow Programmer (WTPROG)	Programmer for Heating and Hot Water cycles, with Service Internal Timer	
Pressure Reducing Valve (WUVP RC)	Designed to regulate the incoming mains pressure to a fixed 1.5 Bar pressure	
Plate Heat Exchanger (WTPHE)	Externally exchanges heat with flow + return to the store, and flow + return to the boiler	
Expansion Vessels (WU2EV)	Optional expansion vessel to absorb excess pressure in secondary pipework	

<p>Ballvalve (WP15BVJ)</p>	<p>Valve to control water flow to Header tank (Float required)</p>	 A brass ball valve with a curved handle and a threaded end.
<p>Plastic Float (WPF4)</p>	<p>Plastic Floats for Ballvalves</p>	 A red spherical plastic float with a small protrusion at the bottom.

Commissioning Checklist

THERMAL STORE MAINS PRESSURE HOT WATER STORAGE SYSTEM COMMISSIONING CHECKLIST

This Commissioning Checklist is to be completed in full by the competent person who commissioned the storage system as a means of demonstrating compliance with the appropriate Building Regulations and then handed to the customer to keep for future reference.

Failure to install and commission this equipment to the manufacturer's instructions may invalidate the warranty but does not affect statutory rights.

Customer Name:

Telephone Number:

Address:

CUBEflow Make & Model:

Production Number:

Commissioned by (PRINT NAME):

Company Name:

Telephone Number:

Company Address:

Commissioning Date:

ALL SYSTEMS				
What is the incoming static cold water pressure at the inlet to the system?				Bar
If above 3.0 Bar, has a pressure reducing valve been fitted?	Yes		No	
Has cold mains strainer been cleaned of installation debris?	Yes		No	
Is the installation in a hard water area (above 200ppm)?	Yes		No	
If yes, has a water scale conditioner/inhibitor been fitted?	Yes		No	
What type of scale conditioner/inhibitor has been fitted?				
Has flow rate been restricted to a maximum of 18 litres at any one outlet?	Yes		No	
Time and temperature controls have been fitted in compliance with Part L of the Building Regulations?				Yes
Type of control system (if applicable)	Y Plan		S Plan	
			Other	
What is the hot water thermostat set temperature?				°C
If fitted, what is the Immersion Heater thermostat temperature?				°C
What is the hot water temperature at the nearest outlet?				°C
What store temperature is the unit sitting at? (Max 80°C)				°C
What is the maximum hot water temperature at taps?				°C
Is the cylinder solar (or other renewables) compatible?	Yes		No	
If a manual fill, has any ball-valve been disconnected or blanked?	Yes		No	
Has the automatic fill flow rate been reduced to ensure the overflow can cope?	Yes		No	
All appropriate pipes have been insulated up to 1 metre or the point where they become concealed?				Yes

ALL SYSTEMS PRIMARY SETTINGS (Indirect Heating Only)

Is the primary circuit a sealed or open vented system?	Sealed	<input type="checkbox"/>	Open	<input type="checkbox"/>
What is the maximum primary flow temperature?				°C

ALL INSTALLATIONS

The hot water system complies with the appropriate Building Regulations.	Yes	<input type="checkbox"/>
The system has been installed and commissioned in accordance with the manufacturer's instructions.	Yes	<input type="checkbox"/>
The system controls have been demonstrated and understood by the customer.	Yes	<input type="checkbox"/>
The manufacturer's literature, including this Checklist, has been explained and left with customer.	Yes	<input type="checkbox"/>

Commissioning Engineer's Signature:

Customer's Signature:

(To confirm satisfactory demonstration and receipt of manufacturer's literature)



McDonald Water Storage

Hot Water Storage Solutions

**Queensway Industrial Estate
Glenrothes
Fife
KY7 5QF**

Tel: (01592) 611123

Fax: (0.1592) 611166

Email: sales@mcdonaldwaterstorage.com



The HWA Charter Statement requires that all members adhere to the following:

- To supply fit for purpose products clearly and honestly described
- To supply products that meet or exceed appropriate standards and building and water regulations
- To provide pre and post technical support
- To provide clear and concise warranty details to customers